

# TECHNICAL FOCUS

## RTX: THE NEW AERMEC ROOF-TOP UNIT OFFERING OPTIMIZED AIR CONDITIONING OF COMMERCIAL FACILITIES ALL YEAR ROUND

### COMFORT SOLUTIONS

In medium occupancy applications within the industrial and service sectors, such as shopping malls, libraries and small production facilities, beyond maintaining the desired temperature and humidity it is also necessary to ensure the right air quality by ensuring the correct amount of air renewal. All these needs can be solved using a single solution, the RTX Roof-Top unit.

Aermec RTX, in addition to satisfy the requirements described above, furthermore offers an extremely compact and versatile package, offering plug and play operation.

The enclosed Technical Focus document concentrates on the potential energy savings obtainable thanks to the new Aermec RTX units for medium occupancy applications, including a case study applied to a shopping mall.

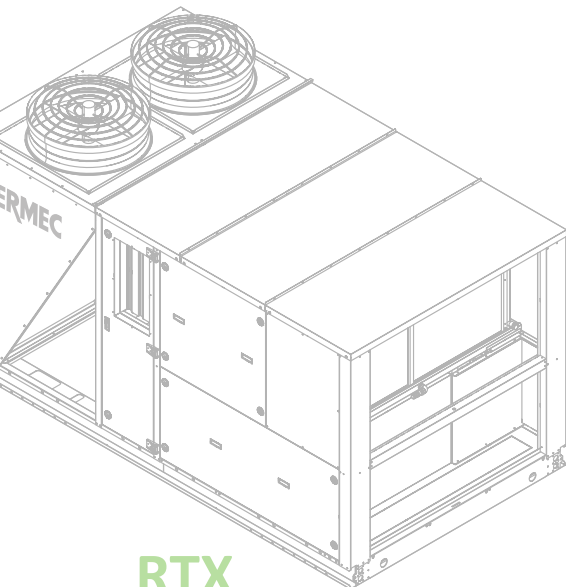

RTX

## SUMMARY

<b>Introduction</b> .....	3
<b>Chapter 1</b> Application of Roof-Top Systems in “Shopping mall” contexts.....	4
<b>Chapter 2</b> The structural evolution of shopping malls .....	5
<b>Chapter 3</b> Analysis of the model “shopping mall” used for energy calculations.....	6
<b>Chapter 4</b> Analysis of loads and consumptions.....	10
<b>Chapter 5</b> Conclusions .....	15



The “Technical Focus” series is intended to offer an example for information only of the possible advantages in the use of innovative Aermec solutions.

As the data and results presented in the publication refer to specific buildings and situations, then these can vary significantly depending on the applications and intended use. For this reason the calculations and considerations made in this document cannot be considered an alternative to the design by a professional engineer.

Aermec reserves the right to carry out at any moment any modifications deemed necessary for the improvement of the product with any modification of published data.

© 2013 Aermec, All right reserved.

Aermec, already present on the European market with a range of Roof-top of power between 10 and 254kW, over the last few years has invested considerable resources in developing new units that present high technological content in order to provide the designer with a valid alternative to the system solution with Air Handling Unit (AHU).

This, has led to a rapid improvement of machinery, resulting in the growth of energy efficiency for generating heating/cooling, and an expansion of the range of accessories.

In the following treatment, we will deal with the calculation of energy consumption of a shopping mall, with the aim of demonstrating the real benefits that the new RTX series brings with respect to the performance of state of the art.

## INTRODUCTION

In this technical document we are going to test the performances and power consumption of the new Aermec Roof-Top RTX model, in relation to a specific system application.

The analysis will be carried out through the development of a specific building model destined to shopping malls. The same model was compared on three European locations characterized by three different climatic zones:

- Oslo (Norway): Colder
- Rome (Italy): Average
- Athens (Greece): Warmer

The performances in terms of primary energy consumption and CO<sub>2</sub> emissions into the environment, allowed to demonstrate in a tangible way the real benefits that the new Roof-Top RTX series involves compared to a solution with similar units for size but not for technology.

The advantages that distinguish the new series RTX are to be found in the presence of a heat recovery from exhaust air (active thermodynamic recovery), a new refrigerant circuit characterized by UNEVEN technology with regenerative heat exchanger, which allows a higher output at partial loads and finally Plug Fans with EC motor for greater savings in energy management dedicated to the air flow rate of exercise.



Installation on the roof of a  
RTX with external air intake

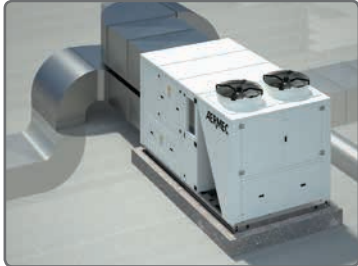

## Chapter 1 APPLICATION OF ROOF-TOP SYSTEMS IN “SHOPPING MALL” CONTEXT

Shopping malls are systems characterized by:

- High energy consumptions and users with high sensitivity to operating costs;
- Low heat losses, through the building envelop;
- High internal loads for lighting the environments;
- Cooling demand also during winter season;
- Installations for cold storage of food of significant power, with consequent availability of important amounts of waste thermal energy.

The type of systems that have become established the most, are:

- Air/air systems;
- Water systems;
- Mixed systems.

In premises of medium/large size, where it is required to maintain the conditions of well-being, then, in addition to a correct value of temperature and humidity, it is also required a high quality of air, it is set the technology of an air/air system; in particular ROOF-TOP and AHU in addition with thermal power plant.

Estimated World Roof-Top  
Market value 2011 by regions:

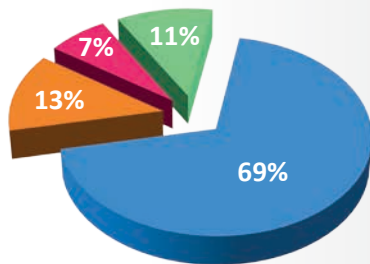

- Pacific Asia
- Europe
- India, Africa
- the Americas

As can be noted from the graph the solution of the Roof-Top has found great use in America, while it has not had the same success in Europe, especially for the following reasons:

- Lack of attention to air quality;
- Low energy efficiencies;
- Little contained noise levels.

These negative aspects, though they were very marked in previous years, have gradually disappeared, due to the use of following measures:

- Use of high efficiency heat recovery units of static and thermodynamic type;
- Use of compressors with low consumption;
- Increase in the external air portion treated for possible use in medium/high crowding environments;
- Wide range of filtration.

ENEA is the Italian National Agency for New Technologies, Energy and Sustainable Economic Development.

An analysis carried out by ENEA on the characterization of the building for commercial use, we noticed that in recent years the trend of buildings has shifted from the classical structure of masonry and reinforced concrete to cheaper and faster frame of prefabricated panels; although there are also shopping malls with a certain percentage of glazed surfaces, the orientation has moved, to the absence of such a component.

## Chapter 2 THE STRUCTURAL EVOLUTION OF SHOPPING MALLS

### STRUCTURE OF THE BUILDING:

	Period of construction			
	Before 1981	From 1982 to 1991	From 1992 to 2001	After 2001
Bearing masonry	-	22,2	1,4	3,4
Mixed reinforced concrete and masonry	62,5	16,7	32,4	37,1
Structure in r.c. and prefabricated panels	25,0	16,7	41,9	38,2
Structure in r.c. and glass	-	27,8	16,2	4,5
Steel and masonry	12,5	-	4,1	5,8
Steel and prefabricated panels in r.c.	-	5,6	-	2,2
Steel and panels of other materials	-	5,6	-	-
Steel and glass	-	5,6	4,1	9,0
Glazed curtain wall	0,0	0,0	0,0	0,0

Source: CRESME's research for ENEA (2011)  
National Agency for New Technologies, Energy and Sustainable Economic Development.

### TRANSPARENT SURFACE WITH RESPECT TO THE TOTAL OPAQUE, VERTICAL SURFACES • RETAIL STORE:

	Period of construction			
	Before 1981	From 1982 to 1991	From 1992 to 2001	After 2001
Absent	50,0	45,2	67,8	64,5
Up to 5%	-	16,1	14,4	11,8
From 5% to 10%	-	9,7	6,7	8,2
From 10% to 15%	25,0	3,2	2,2	0,9
From 15% to 20%	(..)	9,7	3,3	0,9
Over 20%	25,0	16,1	5,6	13,6

Source: CRESME's research for ENEA (2011)  
National Agency for New Technologies, Energy and Sustainable Economic Development.

### TYPE OF GLAZING SURFACES:

	Period of construction			
	Before 1981	From 1982 to 1991	From 1992 to 2001	After 2001
Single glazing	50,0	13,3	24,0	16,7
Double glazing	33,3	73,3	64,0	75,0
Triple glazing	-	13,3	12,0	8,3
Other	16,7	-	-	-

Source: CRESME's research for ENEA (2011)  
National Agency for New Technologies, Energy and Sustainable Economic Development.

### TYPE OF COVERING:

	Structure of the building							
	Bearing masonry	Mixed r.c. and masonry	Structure in r.c. and prefabricated panels	Structure in r.c. and glass	Steel and masonry	Steel and prefabricated panels in r.c.	Steel and glass	Glazed curtain wall
Flat in brick	37,5	46,7	22,5	33,3	25,0	11,1	66,7	-
Flat in prefabricated panels	25,0	31,1	53,5	41,7	-	44,4	-	50,0
Shed	-	4,4	1,4	8,3	25,0	11,1	-	-
Pitched strata	12,5	6,7	9,9	-	25,0	-	-	-
Metallic or tensostructures	12,5	11,1	11,3	8,3	25,0	22,2	33,3	-
Other	12,5	-	1,4	8,3	-	11,1	-	50,0

Source: CRESME's research for ENEA (2011)  
National Agency for New Technologies, Energy and Sustainable Economic Development.

### Chapter 3

## ANALYSIS OF THE MODEL "SHOPPING MALL" USED FOR ENERGY CALCULATIONS

The Italian Thermal Engineering Committee has generated the schedules, which shows the stratigraphy with the respective thermo-hygro-metric structures: walls, ceilings, floors.

Listed below are the stratigraphy used to perform the calculations of heat exchanges for transmission.

In heat exchange for transmission, the thermal capacity of the structure has been evaluated, so the capacity that the casing has to accumulate and release heat within the considered environment.

#### STRATIFICATION OF VERTICAL WALLS

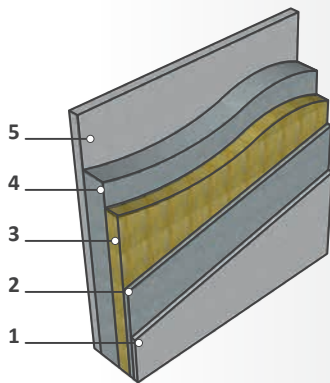

Coeff. of global transmittance:  
 $U = 0,671 \text{ W/m}^2\text{K}$

#### Opaque walls

LAYER	d [cm]	$\rho$ [kg/m <sup>3</sup> ]	$c$ [J/(kg K)]	$\lambda$ [W/m K]	$R$ [m <sup>2</sup> K/W]
1 Interior plaster	1	1400	1000	0,700	-
2 Concrete panel	1	1400	1000	0,580	-
3 Fiber glass insulation panel	3	30	670	0,040	-
4 Concrete panel	5-30	1400	1000	0,580	-
5 External plaster	2	1800	1000	0,900	-

Description (thickness in cm)	U [W/(m <sup>2</sup> K)]	km [kJ/(m <sup>2</sup> K)]	$Y_{ie}$ [W/(m <sup>2</sup> K)]
1 - 1 - 3 - 5 - 2	0,943	30,5	0,818
1 - 1 - 3 - 10 - 2	0,872	33,1	0,555
1 - 1 - 3 - 15 - 2	0,811	32,4	0,341
1 - 1 - 3 - 20 - 2	0,758	30,9	0,209
1 - 1 - 3 - 25 - 2	0,712	29,5	0,130
1 - 1 - 3 - 30 - 2	0,671	28,6	0,082

Source: Italian Thermal Engineering Committee for Energy and Environment, doc. GL102-SG02 "Thermal Transmittance"

#### STRATIFICATION OF FLOOR

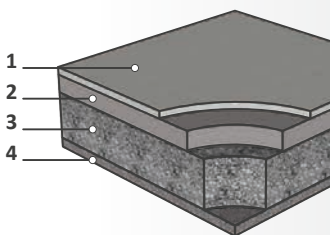

Coeff. of global transmittance:  
 $U = 1,325 \text{ W/m}^2\text{K}$

#### Concrete slab against ground

LAYER	d [cm]	$\rho$ [kg/m <sup>3</sup> ]	$c$ [J/(kg K)]	$\lambda$ [W/m K]	$R$ [m <sup>2</sup> K/W]
1 Interior flooring- stoneware <sup>(1)</sup>	1,5	1700	1000	1,470	-
2 Cement mortar	3	2000	1000	1,400	-
3 Lightened concrete	10	1200	1000	0,330	-
4 Scree- river pebbles	20-40	1700	1000	1,200	-

<sup>(1)</sup> By way of example it is assumed a ceramic stoneware flooring

Description (thickness in cm)	U [W/(m <sup>2</sup> K)]	km [kJ/(m <sup>2</sup> K)]	$Y_{ie}$ [W/(m <sup>2</sup> K)]
1,5 - 3 - 10 - 20	1,490	-	-
1,5 - 3 - 10 - 30	1,325	-	-
1,5 - 3 - 10 - 40	1,193	-	-

Source: Italian Thermal Engineering Committee for Energy and Environment , doc. GL102-SG02 "Thermal Transmittance"

## STRATIFICATION OF COVERING

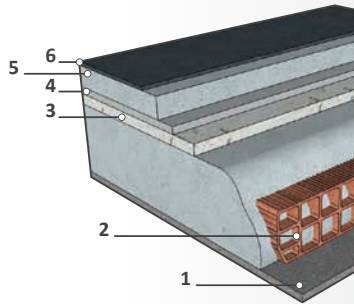

Coeff. of global Transmittance:  
 $U = 1,407 \text{ W/m}^2\text{K}$

## Non practicable flat covering

LAYER	d [cm]	$\rho$ [kg/m <sup>3</sup> ]	c [J/(kg K)]	$\lambda$ [W/m K]	R [m <sup>2</sup> K/W]
1 Interior plaster	2	1400	1000	0,700	-
2 Insole (blocks in brick+concrete joists)	16-24	900	1000	-	0,330-0,370 <sup>(2)</sup>
3 Reinforced concrete	4	2400	1000	-	0,330-0,370 <sup>(2)</sup>
4 Cement mortar	2	2000	1000	-	0,330-0,370 <sup>(2)</sup>
5 Ordinary concrete screed	2-12	2000	1000	1,060	-
6 Bituminous waterproofing membrane	1	1200	1000	0,170	-

<sup>(2)</sup> thermal resistance according to UNI 10355

Description (Thickness in cm)	U [W/(m <sup>2</sup> K)]	km [kJ/(m <sup>2</sup> K)]	Y <sub>ie</sub> [W/(m <sup>2</sup> K)]
2-16-4-2-2-1	1,735	-	-
2-16-4-2-6-1	1,629	-	-
2-16-4-2-12-1	1,491	-	-
2-24-4-2-2-1	1,623	-	-
2-24-4-2-6-1	1,529	-	-
2-24-4-2-12-1	1,407	-	-

Source: Italian Thermal Engineering Committee for Energy and Environment, doc. GL102-SG02 "Thermal Transmittance"

To obtain an absorption coefficient of the roof of 0,3, it was necessary to consider a painted surface of light grey, while for walls is considered an absorption coefficient of 0,7 (dark grey).

These parameters are crucial for determining for proportion of incident solar radiation that is transferred inside the building.

In addition, please note that for the calculation of the thermal behaviour under dynamic conditions of the building, it has been considered the regulation UNI EN ISO 13786:2008 and UNI 10375: 2011.



## ROOF-TOP SYSTEMS IN SHOPPING MALL CONTEXT

### FEATURES OF SHOPPING MALLS

#### Building dimensions:

Height: 4,5m  
Length: 110m  
Width: 70m  
Surface: 7700m<sup>2</sup>  
Volume: 34650m<sup>3</sup>



#### Input and output dimensions:

Height: 2,5m  
Length: 4m x 2 - Total surface 20m  
Position: south side input and west side output

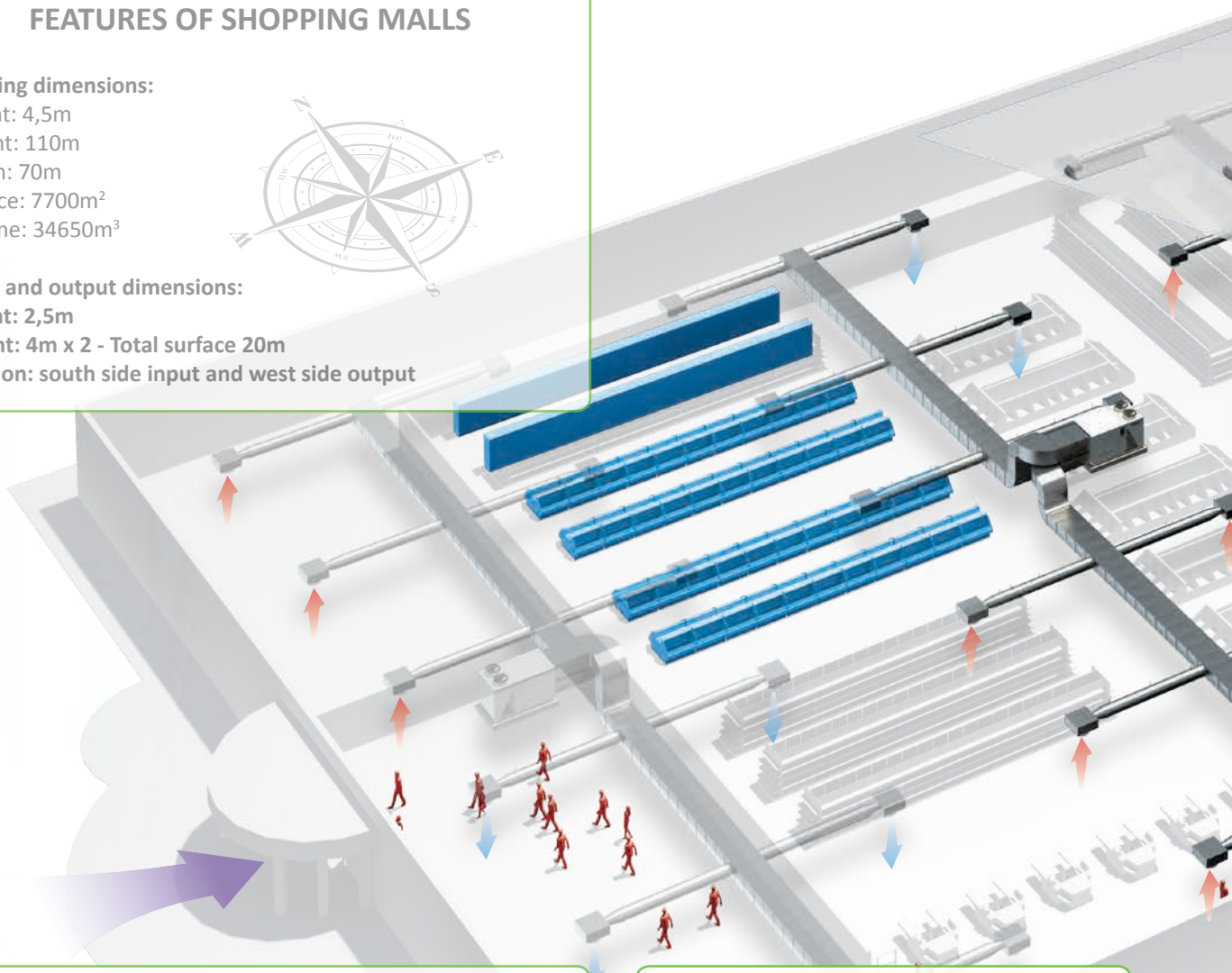

### AFFLUENCE OF PEOPLE

Hourly trend of the flow of people inside the shopping mall. The maximum number of customers was obtained by considering 1 person every 6m<sup>2</sup> of usable surface.

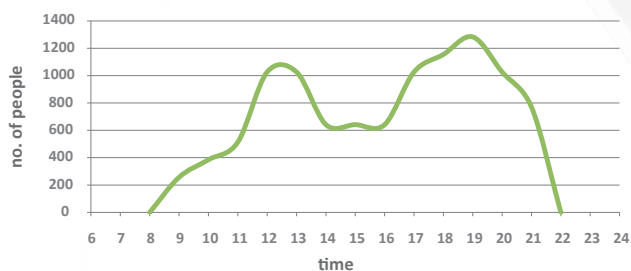

### LOCATION

Analysis of the hourly trend of temperature obtained by BIN METHOD for following European cities:

Oslo (Norway): Colder  
Rome (Italy): Average  
Athens(Greece): Warmer



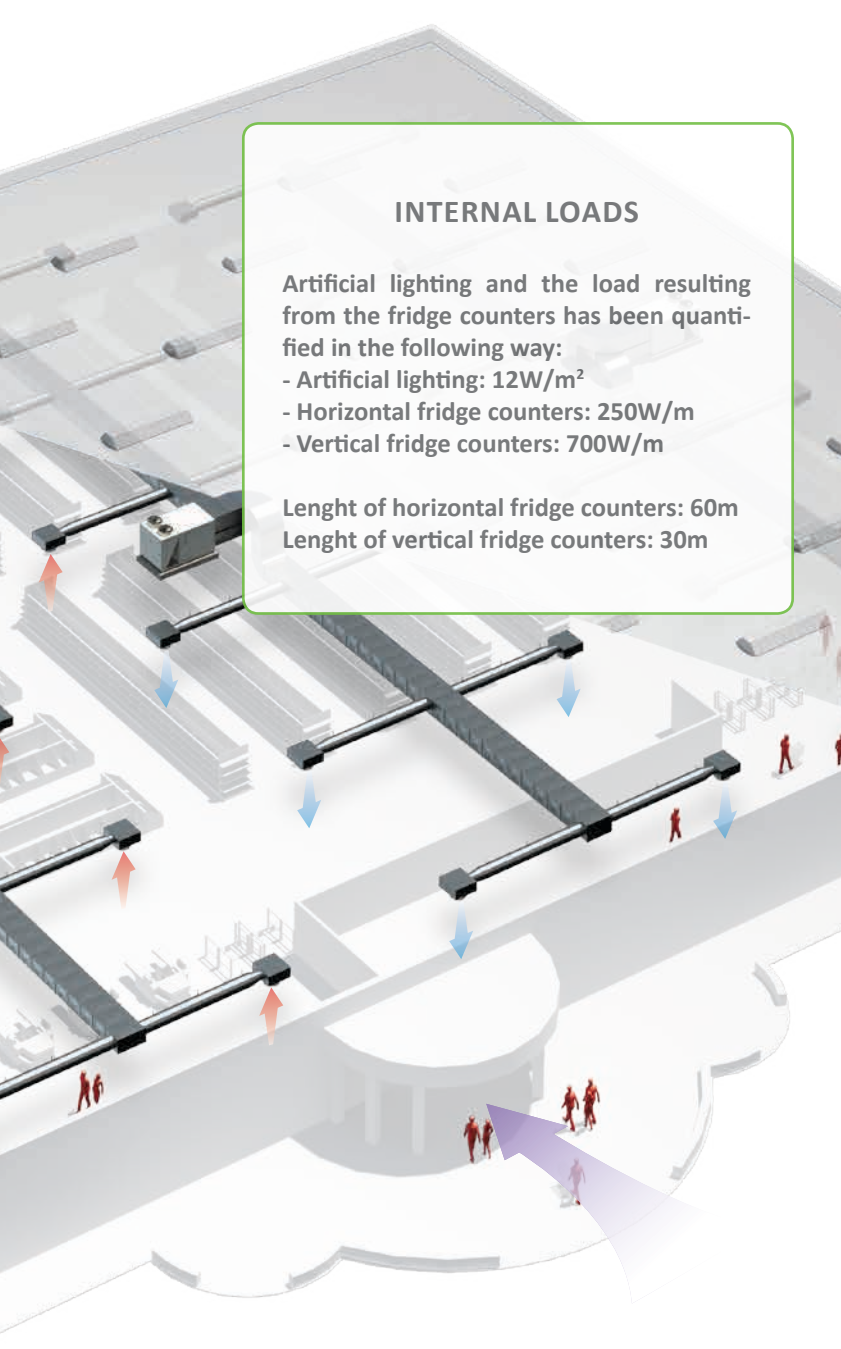

### INTERNAL LOADS

Artificial lighting and the load resulting from the fridge counters has been quantified in the following way:

- Artificial lighting: 12W/m<sup>2</sup>
- Horizontal fridge counters: 250W/m
- Vertical fridge counters: 700W/m

Length of horizontal fridge counters: 60m  
 Length of vertical fridge counters: 30m

### INTERNAL CONDITIONS

The internal conditions considered for the three examined cases are common:

#### WINTER

Room temperature 20°C / relative humidity 50%

#### SUMMER

Room temperature 26°C / relative humidity 50%

### TREATED AIR FLOWS

#### Rome:

Total air flow discharge 72.000m<sup>3</sup>/h  
 Volumes/hours 2,1Vol/h

#### Oslo:

Total air flow discharge 66.000m<sup>3</sup>/h  
 Volumes/hours 1,9Vol/h

#### Athens:

Total air flow discharge 72.000m<sup>3</sup>/h  
 Volumes/hours 2,1Vol/h

- Fridge counters
- Supply air Roof Top
- Return air Roof Top
- External air leakages

### SIZING

The examined Roof-Top were sized to cover the loads:

- Rome: n°4 RTX 13 (MB3)
- Oslo: n°3 RTX 15 (MB3)
- Athens: n°3 RTX 16 (MB3)

The volume of fresh air is equal to 20m<sup>3</sup>/h per person.

**CLIMATE PROFILE  
ROME**

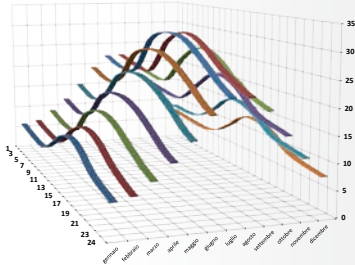

**CLIMATE PROFILE  
OSLO**

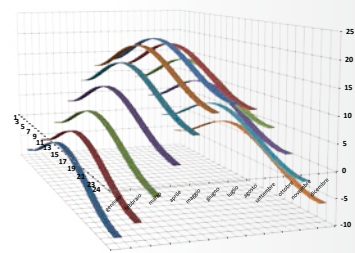

**CLIMATE PROFILE  
ATHENS**

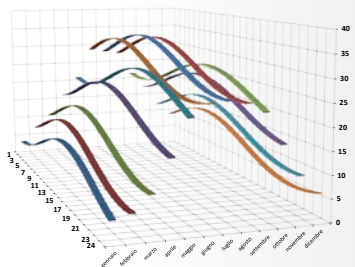

**Chapter 4  
ANALYSIS OF LOADS AND CONSUMPTIONS**

For the analysis of the shopping mall's thermal load, we have hypothesized a maximum crowding of people equal to one person every six square meters of usable floor area.

The affluence shows a peak in the early part of the day, from 11.00 to 14.00, while the afternoon slot is considered from 18.00 to 20.00, seven days a week.

The constant comings and goings of customers, leads to a heat input in winter, while it generates a heat load to be subtracted during the summer.

The continuous infiltration of outside air due to the repeated opening of the shopping mall's doors, cannot be neglected because it implies a significant change in the indoor climatic conditions.

Other factors that influence the energy calculations are artificial lighting, assumed 12W/mq and fridge counters; these were divided in 2 broad categories: the horizontal fridge counters (250W/m) and the vertical fridge counters (700W/m).

With regard to the external air conditions and solar radiation are considered three benchmark cities: Rome, Athens and Oslo.

The hourly trend of temperature has been achieved through the use of BIN METHOD, starting with the minimum and maximum average monthly temperatures, derived from the historical meteorological of the three considered cities.

For the calculation of the specific humidity, were hypothesized reference values: 50% relative humidity in summer and 80% relative humidity in winter period, combined with respective hourly temperature.

The incident solar radiation was obtained by calculating the solar mask, then by considering all the angles: inclination, latitude, declination, surface azimuth and hour angle.

Once we know all these informations, it was possible to calculate the annual energy consumption for the shopping mall's air conditioning in the three European capitals.

**GRAPHICS OF SHOPPING MALL'S SENSITIVE LOADS**

**ROME**

The maximum total sensitive load is equal to 258kW - at 19.00 "July".

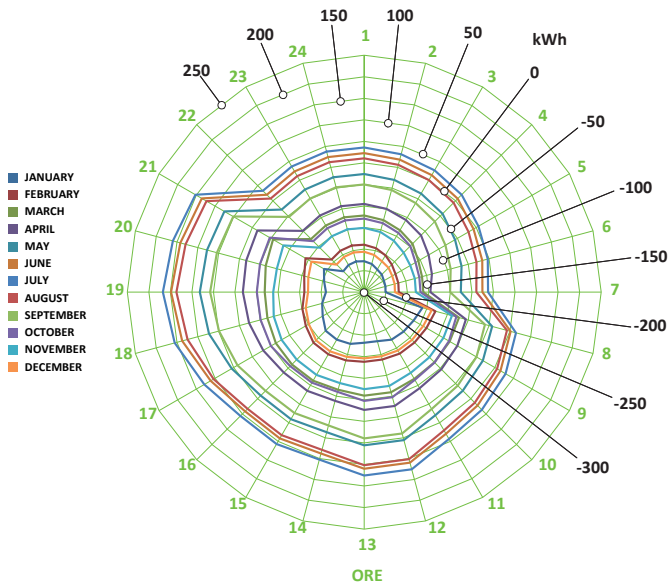
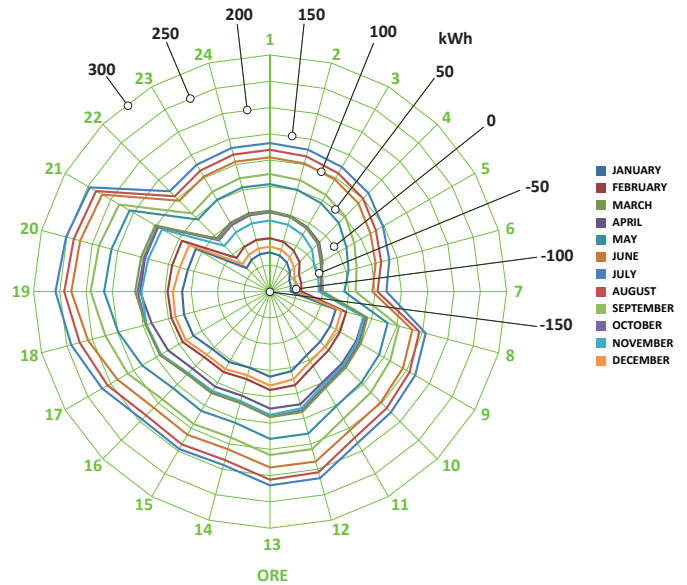

**OSLO**

The maximum total sensitive load is equal to 250kW - 07.00 a.m. "January".

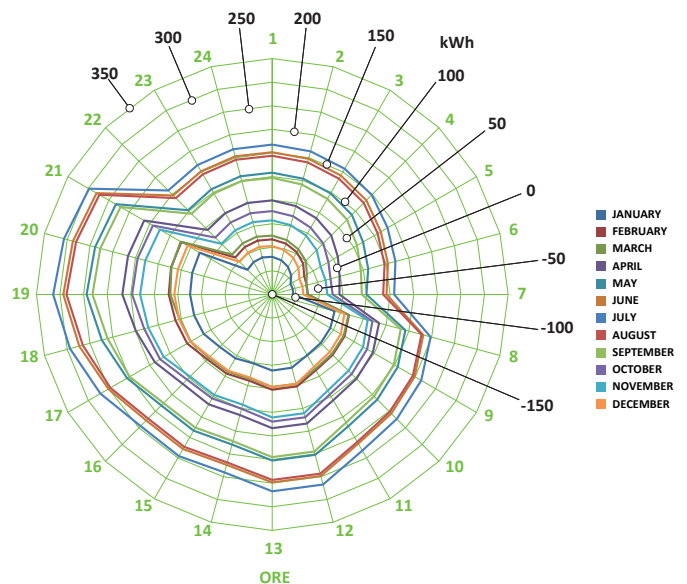

**ATHENS**

The maximum total sensitive load is equal to 314kW - at 19.00 "July".

**GRAPHICS OF SHOPPING MALL'S LATENT LOADS**

**ROME**

The maximum total latent load is equal to 97kW - at 19.00 "July".

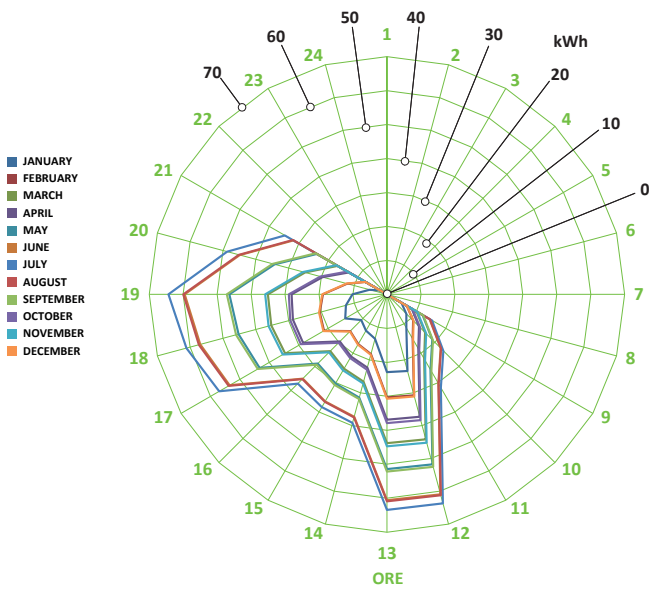
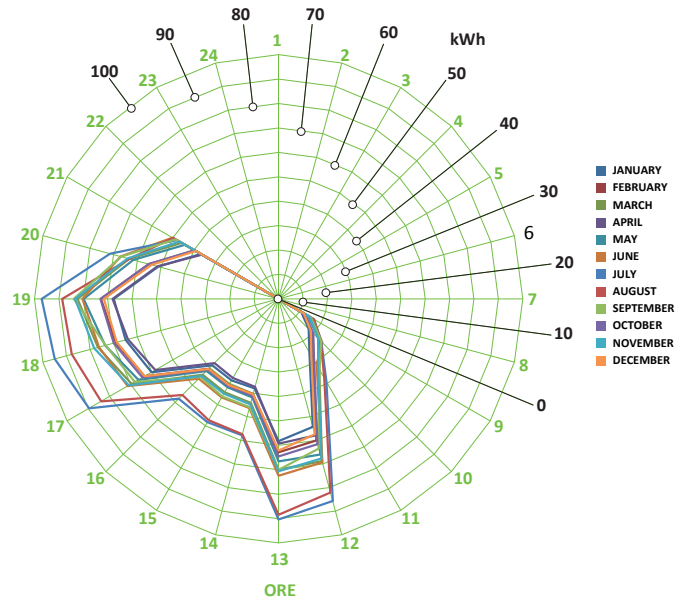

**ATHENS**

The maximum total latent load is equal to 93kW - at 19.00 "July".

**OSLO**

The maximum total latent load is equal to 64kW - at 19.00 "July".

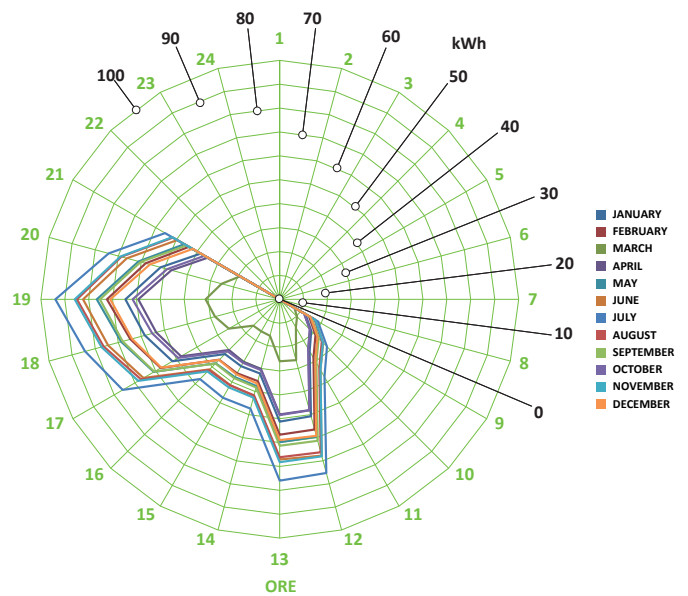



The sensitive load per hour on the maintenance of comfort conditions, was conducted by considering exchanges for transmission, ventilation, radiation and internal heat loads.

This calculation was performed under dynamic conditions, considering the storage capacity of the structure, considering then the attenuation and the thermal gap that this entails.

In the same way, the latent load per hour has been made by considering the contribution due to the infiltration of air and people, related to the entrance and exit doors.

It is also noted that for the renewal of the air is considered a minimum flow rate of 20m<sup>3</sup>/h per person, in relation to the presence of hypothesized customers.

Once defined the latent and sensitive loads, we pass to the sizing of Roof-Top unit:

- Rome: n°4 Roof-Top, model RTX 13 (setting up MB3).
- Oslo: n°3 Roof-Top, model RTX 15 (setting up MB3).
- Athens: n°3 Roof-Top, model RTX 16 (setting up MB3).

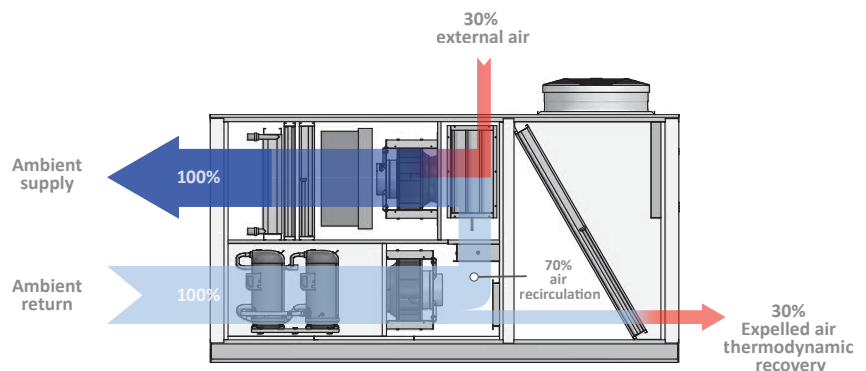

To compare the three system solutions mentioned above, we have considered roof-top systems, whose performances are aligned to the state of the art: the presence of the static recovery with the same percentage of fresh air (30%), useful in keeping the parts of hypothesized fresh air.

Of course, so as not to skew the results, we have kept the same number of units, for the respective location of reference, therefore treating the percentage of fresh air.

The tables below provide comparison charts that summarize the primary energy consumption and CO<sub>2</sub> emissions in the environment for the considered locations. The primary energy consumptions have been obtained on the basis of the data presents in the European regulation UNI EN ISO 15603:2008. This directive proposes the factors of conversion of electrical energy into primary energy, which are specific to the various European countries: for the case here examined, it has been considered a conversion factor of 2,60 (average of the factors listed in the following table).

Primary energy factors (pefs) for the production of electricity in relation to specific European locations.

	PEFs
-	2,58
France	2,60
Germany	2,56
Holland	3,00
Poland	2,60
Spain	2,00
Sweden	2,92
England	

UNI ISO 15603: 2008

Primary energy consumption - average conversion factor in Europe  
PEFs 2,60

European Regulation UNI EN ISO 15603: 2008

Conversion factors emission of CO <sub>2</sub>	
Italy	406gr/kWhe
Norway	16gr/kWhe
Greece	718gr/kWhe
<b>*Europe (OECD)</b>	<b>330gr/kWhe</b>

Source IEA: International Energy Agency

\* Average European coefficient used for the calculation of CO<sub>2</sub> emissions in the three respective European locations.

### ANNUAL CONSUMPTION OF PRIMARY ENERGY

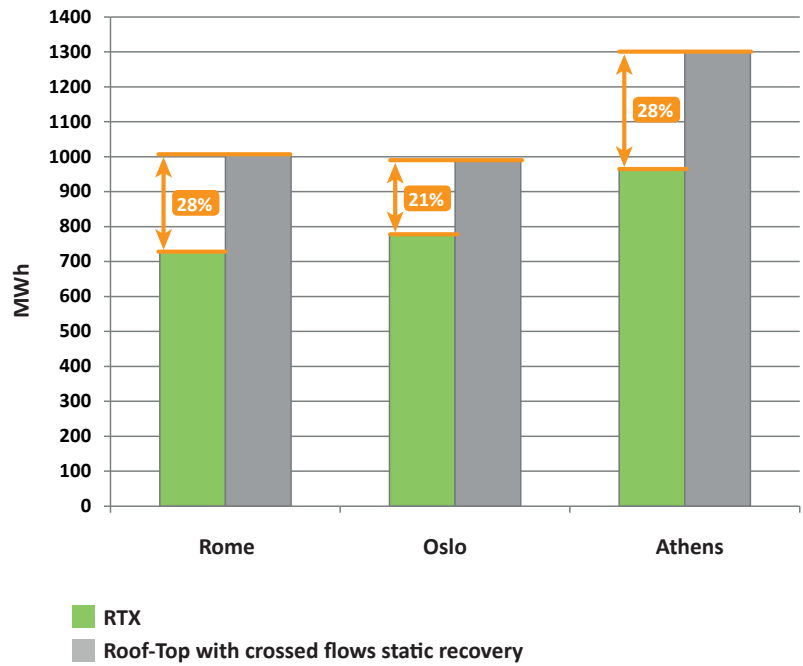

### ANNUAL EMISSIONS OF CO<sub>2</sub> IN THE ENVIRONMENT

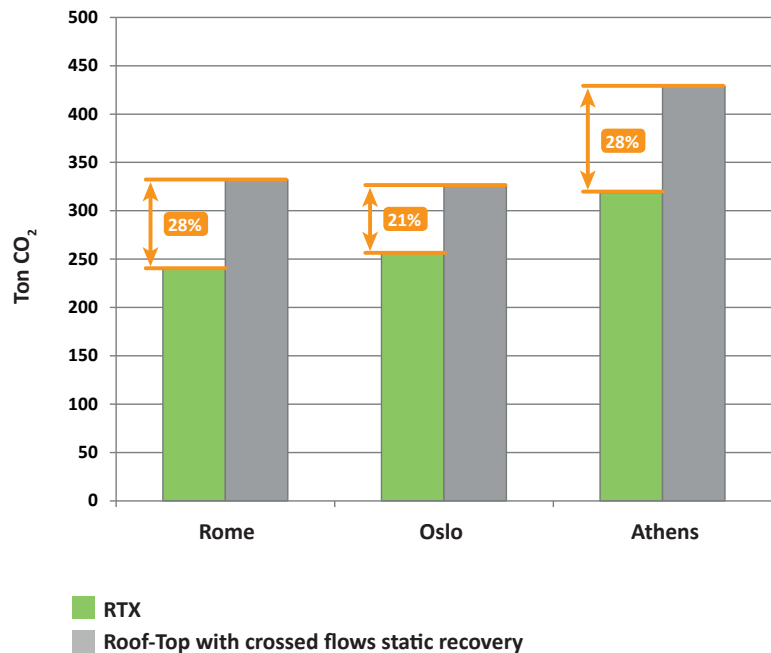



For more informations about the RTX series, please consult the product data sheets on Aermec's website.

Data sheet RTX



Aermec has developed in parallel the RTX series for medium crowding applications, a new series called RTY for high-crowding applications. For more informations about the RTX series, please consult the product data sheets on Aermec's website.

Data sheet RTY



## Chapter 5 CONCLUSIONS

The energy analysis dealt with in this Technical Focus, allowed us to compare the existing Roof-Top on the market with new RTX Aermec. In terms of primary energy consumed, you get a significant savings, regardless of the climate question. In the case of Rome you get a saving of 28% on annual basis, as opposed to Oslo with a 21% and finally Athens with 28%.

This saving results in an improvement of the building's energy, and thus is a valuable aid in the design phase to define plant systems that responds fully to the Regulation 2009/28/CE April 23rd 2009 on the promotion of energy from renewable sources.

This significant result is to be found in the use of technological improvements that characterize the new range RTX.

It is remarkable the advantage deriving from the use of refrigerant circuits developed with the logic "Uneven": it improves the performances at partial loads, because, despite having two compressors in tandem on a single circuit, we can count on three capacity steps. We also reduced electricity consumption for ventilation with the adoption of Plug Fans with EC motors.

In addition the action of thermodynamic recovery on the expulsion air, trick that has been adopted by a special mixing chamber, allowing an increase in performance during the whole year of operation.

Last but not least, the issue relating to the reduction in terms of CO<sub>2</sub> emitted into the environment. Significant differences are found in the three documented energy comparisons.

All this make the new Aermec RTX series, a possible high-efficiency instrument useful for the purpose of acquiring and always match the highest standards of energy savings related to the certification of the energy performance of a possible building.

**Aermec S.p.A. via Roma 996 - 37040 Bevilacqua (VR) Italy**  
**T. +39 0442 633111 F. +39 0442 93577**  
**sales@aermec.com**  
**www.aermec.com**

A decorative graphic at the bottom of the page consisting of several overlapping, wavy, light gray bands that create a sense of movement and depth.